

www.cnbtec.com

XPEED Outdoor Series Ver 1.0

INSTALLATION AND OPERATION MANUAL

(3810-0250A_110119)

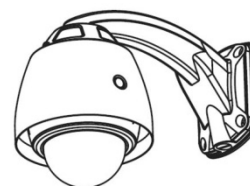
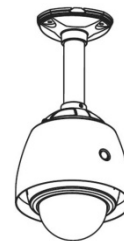
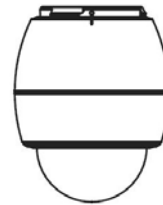

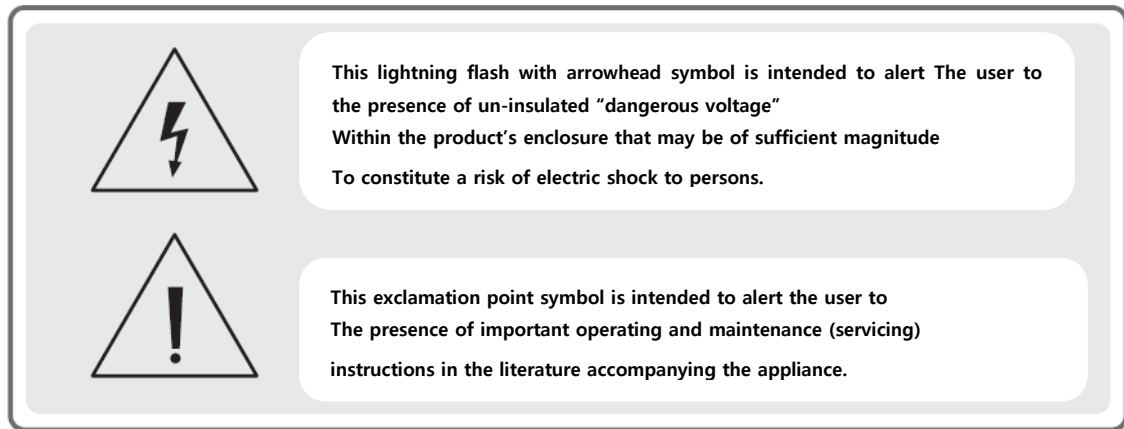

⊙ Important Safety Instructions

■ Read Instructions

- Read all of the safety and operation instructions before using the product.

■ Retain Instructions

- Save these instructions for future reference.

■ Attachments / Accessories

- Do not use attachments or accessories unless recommended by the appliance manufacturer as they may cause hazards, damage product and void warranty.

■ Installation

- Do not place or mount this product in or on an unstable or improperly supported location. Improperly installed product may fall, causing serious injury to a child or adult, and damage to the product. Use only with a mounting device recommended by the manufacturer, or sold with the product. To insure proper mounting, follow the manufacturer's instructions and use only mounting accessories recommended by manufacturer.

■ Power source

- This product should be operated only from the type of power source indicated on the marking label.

⊙ Precautions

■ Operating

- Before using, make sure power supply and others are properly connected.
- While operating, if any abnormal condition or malfunction is observed, stop using the camera immediately and then contact your local dealer.

■ Handling

- Do not disassemble or tamper with parts inside the camera.
- do not drop or subject the camera to shock and vibration as this can damage camera.
- Care must be taken when you clean the clear dome cover. Especially, scratch and dust will ruin your quality of camera.

■ Installation and Storage

- Do not install the camera in areas of extreme temperature, which exceed the allowable range.
- Avoid installing in humid or dusty places.
- Avoid installing in places where radiation is present.
- Avoid installing in places where there are strong magnetic fields and electric signal.
- Avoid installing in places where the camera would be subject to strong vibrations.

☉ Table of Contents

1. Introduction

Features	4
Product & Accessories	6
Parts Name & Functions	7

2. Installation

Dip Switch Setup	8
Installation Using the Wall Mount	11
Installation Using the Pendant Mount	12
Wire Connections	13

3. Operation

Check Points before Operation	15
Preset and Pattern Function Pre-Check	15
Starting OSD Menu	15
Reserved Preset	15
Preset	16
Swing	16
Pattern	16
Group	17
Other Functions	17

4. OSD Menu

OSD Display of Main Screen	18
General Rules of key Operation for Menu	19
Main Menu	19
Display Setup	19
Privacy Zone Mask Setup (26x (S2465N(P)X), 36x (S2965N(P)X) EXview 27x(SCN-22Z27F /SCN-23Z27F) (Option) Models Only)	20
Camera Setup (27x (SCN-22Z27F /SCN-23Z27F models)	21
Camera Setup (26x (S2465N(P)X), 36x (S2965N(P)X) EXview Models)	23
Motion Setup	25
Preset Setup	26
Swing Setup	28
Patten Setup	29
Group Setup	30
System Initialize	32

5. Specifications

26x (S2465N(P)X) EXview Models	33
27x (SCN-22Z27F/SCN-23Z27F) Models	34
36x (S2965N(P)X) EXview Models	35
Dimensional Drawings	36

6. System Models and Related Accessories

System Model Numbers	38
Related Accessories	38

1. Introduction

⦿ Features

■ Camera Specifications

- Image Pick-up Device: 1/4" Interline Transfer CCD
- Zoom Magnification: 26x Optical Zoom, 12x Digital Zoom (Max. 312x Zoom) → Model S2465N(P)X
 27x Optical Zoom, 10x Digital Zoom (Max. 270x Zoom) → Model SCN-22Z27F /SCN-23Z27F
 36x Optical Zoom, 12x Digital Zoom (Max. 432x Zoom) → Model S2965N(P)X
- Day & Night Function
- Various Focus Mode : Auto-Focus / Manual Focus / SemiAuto Focus.
- Each Preset has its own video configuration, label, relay output setting values.
 You can adjust each Preset setting independently.

■ Powerful Pan/Tilt Functions

- Max. 360°/sec high speed pan/Tilt Movement
- Using Vector Drive Technology, Pan/Tilt motions are accomplished in a shortest path. As a result, time to target view is reduced dramatically and the video on the monitor is very natural to watch.
- For jog operation using a controller, since ultra slow speed 0.05°/sec can be reached, it is very easy to locate camera to desired target view. Additionally it is easy to move camera to a desired position with zoom-proportional pan/tilt movement.

■ Preset, Pattern, Swing, Group, Privacy Mask and More...

- Max. 127 Presets are assignable and characteristics of each preset can be set up independently, such as white Balance, Auto Exposure, Label, Digital Outputs and so on.
- Max. 8 set of Swing action can be stored. This enables to move camera repetitively between two preset positions with designated speed.
- Max. 4 of patterns can be recorded and played back. This enables to move camera to follow any trajectory operated by joystick as closely as possible.
- Max. 8 set of Group action can be stored. This enables to move camera repetitively with combination of preset or pattern or Swing. A Group is composed of Max. 20 entities of Preset/Patten/Swings.
- Privacy Masks are assignable, not to intrude on other's privacy. (8 Privacy Zones)
 → Only available with Models S2465N(P)X, S2965N(P)X, SCN-22Z27F /SCN-23Z27F (option)

■ PTZ(Pan/Tilt/Zoom) Control

- With RS-485 communication, Max. 255 of cameras can be controlled at the same time.
- Pelco-D, Pelco-P, Samsung or Panasonic protocol can be selected as a control protocol in the current version of firmware.

■ OSD(On Screen Display) Menu

- OSD menu is provided to display the status of camera and to configure the functions interactively.
- The information such as Camera ID, Pan/Tilt Angle, Alarm I/O and Preset can be displayed on screen.

■ Alarm I/O Functions

- 4 alarm sensor inputs and 2 alarm Output relays are available.
- To reject external electric noise and shock perfectly, alarm sensor Input is decoupled with photo coupler and the relay is used for alarm output.
- The signal range of sensor input is from DC 5.0 to 12.0 volts to adopt various applications. Meanwhile, the maximum load of relay contact is 250VAC, 3A or 28VDC, 3A.
- If an external sensor is activated, camera can be set to move to the corresponding Preset position. Meanwhile, the output relay can be matched to some specific preset positions to do counteractions such as turning on the light or sound the alarm.

■ Reserved Presets for Special Purpose

- Most camera characteristics can be set up easily and directly with reserved preset, not entering into OSD menu. For more information, refer to "Reserved Preset" in this manual.

■ Easy Installation and Perfect Outdoor Environment Compatibility

- Fans and heaters are built-in camera for cold and hot temperature environment.
Also idealistic mechanical design protects camera from water and dust. (IP 66)
- It is easy to install and maintain camera with terminal for cable connection in brackets.

1. Introduction

○ Product & Accessories

■ Basic Components

Main Body & Others

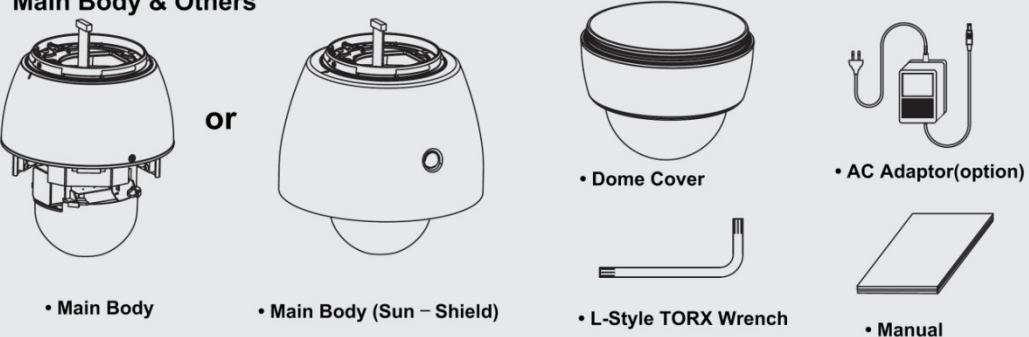

- Main Body
- Main Body (Sun - Shield)
- Dome Cover
- AC Adaptor(option)
- L-Style TORX Wrench
- Manual

Camera Bracket & Bracket Accessories

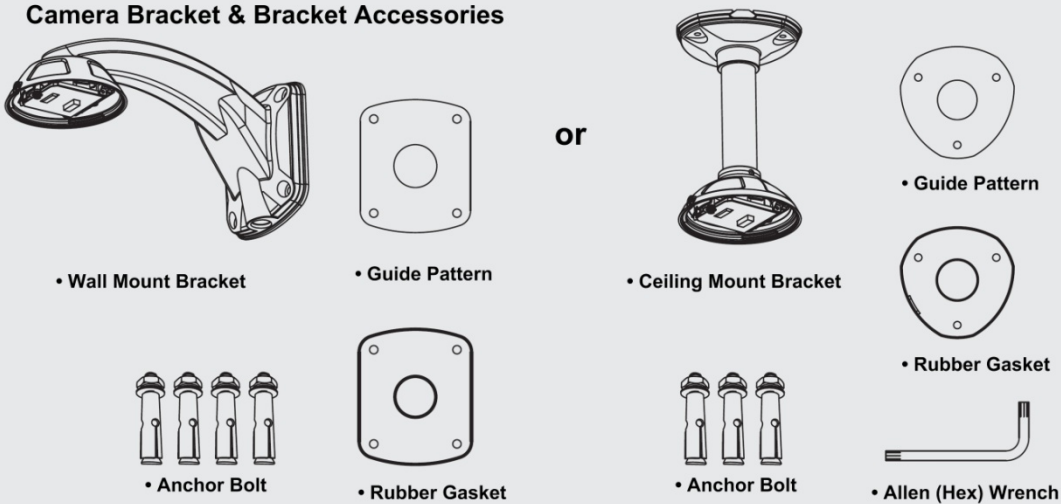

- Wall Mount Bracket
- Guide Pattern
- Ceiling Mount Bracket
- Rubber Gasket
- Anchor Bolt
- Allen (Hex) Wrench

■ Other Components (available to be ordered separately)

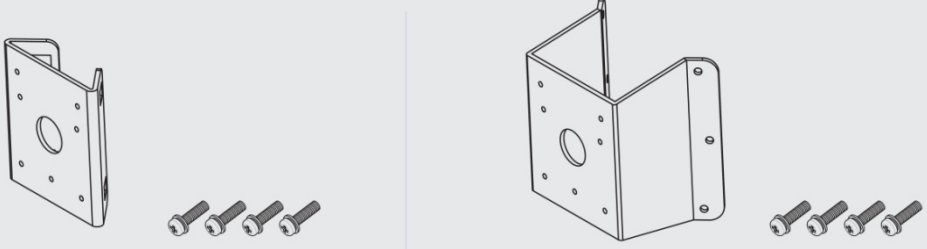

- Pole Mount Adapter
- Sems Screw
- Corner Mount Adapter
- Sems Screw

1. Introduction

○ Parts Name & Functions

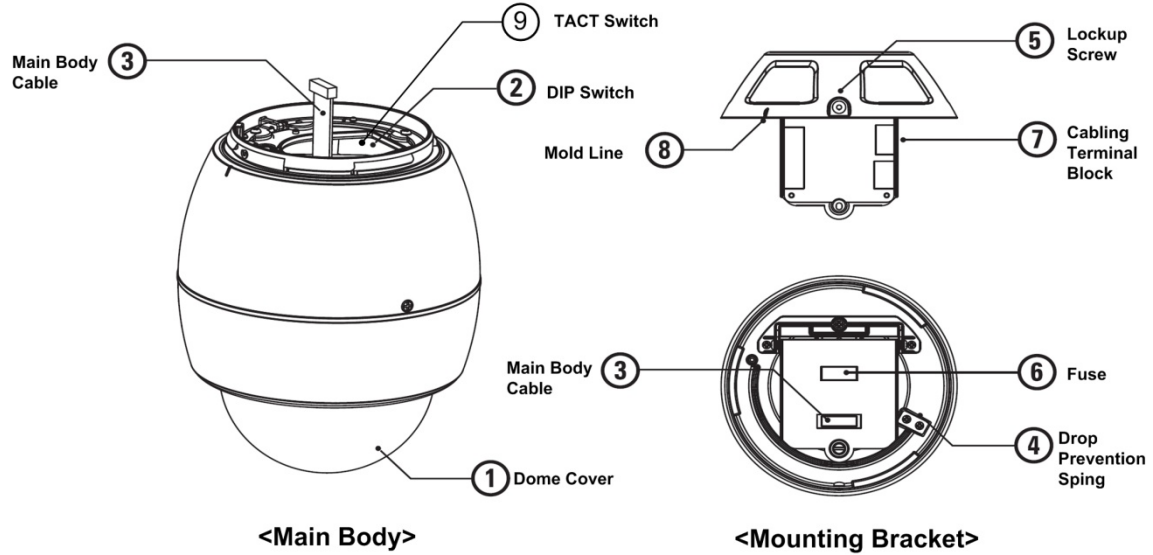

- ① **Dome Cover** Do not detach protection vinyl from dome cover before finishing all installation process to protect dome cover from scratches or dust.
- ② **DIP Switch** Sets up camera ID and protocol.
- ③ **Main Body Cable** Enables signals and power to come and go between main body and mount bracket.
- ④ **Drop Prevention Spring** This part keeps the camera from dropping during installation and maintenance. After install the Bracket, please, hang the spring to the drop prevention hook of main body as shown in picture for further tasks.
- ⑤ **Lockup Screw** After assembling main body to bracket, screw main body to bracket to protect them from separation by vibration and so on.
- ⑥ **Fuse** If the fuse is burnt to protect your came from over-current damage, the fuse have to be replace with new one. The fuse specification is 250V 2A. however, we recommend consulting with supplier to remove the cause of over-current.
- ⑦ **Cabling Terminal Block** During installation, Power, Video, Communication, Alarm I/O cables are connected on to this cables terminal block.
- ⑧ **Mold Line** Mark to assemble main body to bracket.
- ⑨ **TACT Switch** Network Board Factory reset

2. Installation

- ✓ Before installing the camera, you should set the DIP switches to configure the camera ID, communication protocol. Do not use the system upgrade terminal.

⊙ DIP Switch Setup

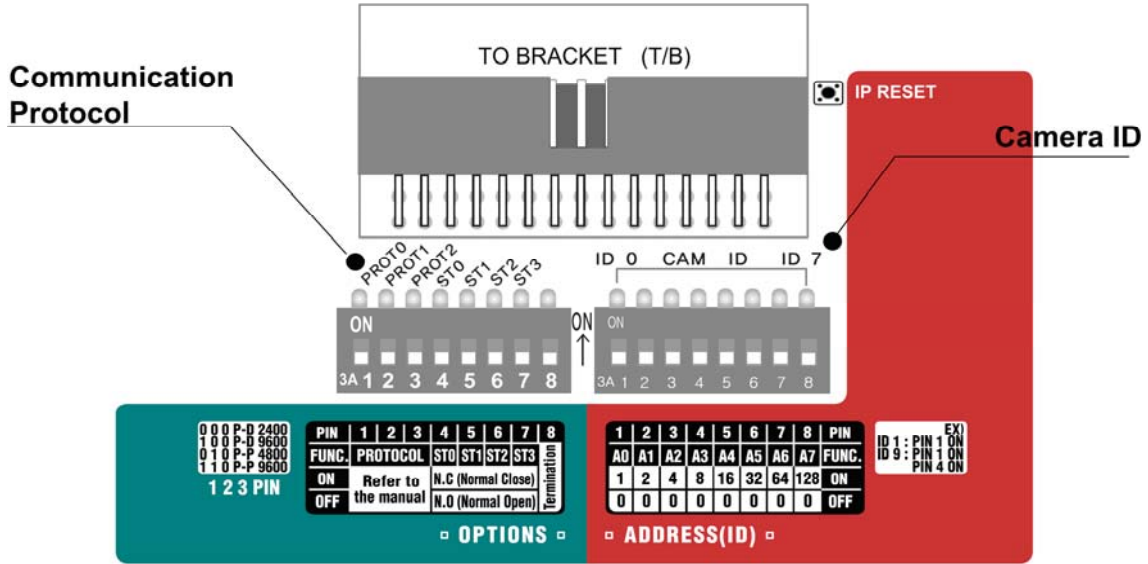

■ Camera ID Setup

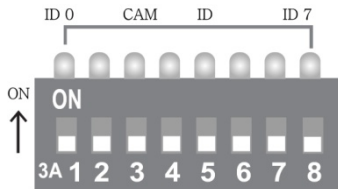

- ID number of camera is set using binary number. The example is shown below.

Pin	1	2	3	4	5	6	7	8
ID Value	1	2	4	8	16	32	64	128
ex) ID=5	ON	OFF	ON	OFF	OFF	OFF	OFF	OFF
Ex) ID=10	OFF	ON	OFF	ON	OFF	OFF	OFF	OFF

- The range of ID 1~255. **Do not use 0 as camera ID.**
- Factory default of Camera ID is 1.
- If you want to control a certain camera, you must match the camera ID with Cam ID setting of DVR or Controller.

2. Installation

■ Communication Protocol Setup

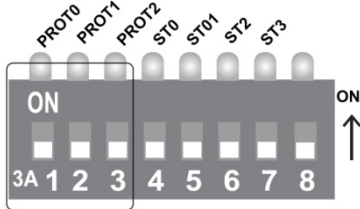

- Select the appropriate Protocol With DIP switch combination.

Switch state			Protocol/Baud rate
P0 (Pin 1)	P1(Pin 2)	P2(Pin 3)	
OFF	OFF	OFF	PELCO-D, 2400bps
ON	OFF	OFF	PELCO-D, 9600bps
OFF	ON	OFF	PELCO-P, 4800bps
ON	ON	OFF	PELCO-P, 9600bps
OFF	OFF	ON	SAMSUNG, 4800bps
ON	OFF	ON	PANASONIC, 9600bps
Others			Reserved

- If you want to control using DVR or P/T controller, their protocol must be identical to camera. Otherwise, you can not control the camera.
- If you changed camera protocol by changing DIP S/W, the change will be effective after you reboot the camera.
- Factory default of protocol is "Pelco-D, 2400bps".

■ Input Sensor Active Type

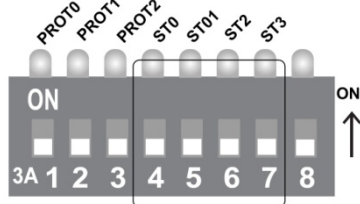

- When a sensor input is used, its functional type should be set. There are two types; Normal Open type and Normal Close type.

-**Normal Open** : Voltage is let out when the sensor is activated

-**Normal Close** : Voltage is let out when the sensor is not activated

Pin	Switch position	Sensor type
ST1 (Pin 4)	ON	Sensor 1 Normal Close
	OFF	Sensor 1 Normal Open
ST2 (Pin 5)	ON	Sensor 2 Normal Close
	OFF	Sensor 2 Normal Open
ST3 (Pin 6)	ON	Sensor 3 Normal Close
	OFF	Sensor 3 Normal Open
ST4 (Pin 7)	ON	Sensor 4 Normal Close
	OFF	Sensor 4 Normal Open

- If a wrong type of sensor is selected, it activates in the opposite way to the sensor input.

■ Termination Switch Setting

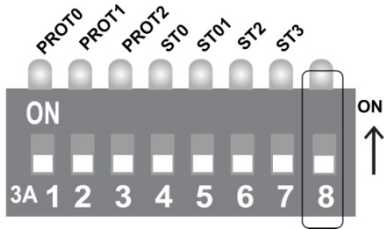

Termination switch (Pin 4) is used in cases listed below.

- **Long-distance communication between the controller and the camera (1-to-1 connection)**
When the connection distance between the two units is especially long, communication errors may occur due to the impedance of transmission cable. In this case, set the termination switch of both units to ON.
- **Controlling multiple cameras (Multiple connection)**
The camera may not operate correctly if multiple cameras are connected and controlled. In this case, set the termination switch of the controller and the last connected camera to ON and the switch of other cameras is OFF.

Ex) Using the Terminating Resistance.

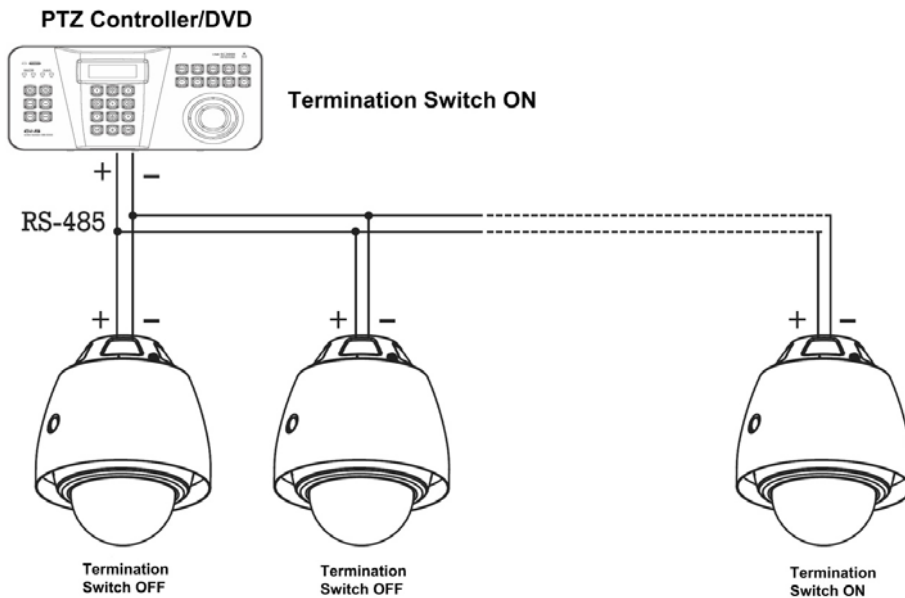

2. Installation

⊙ Installation Using the Wall Mount

① Install Wall Mount Bracket on wall.

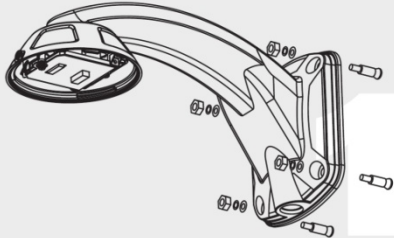

② Wire cables to terminal blocks on the PCB in Wall Mount Bracket.

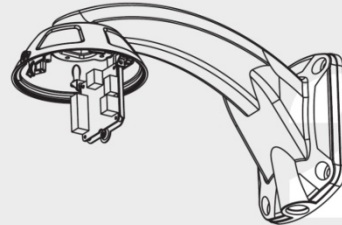

③ Hook up "Drop Prevention Spring" on main body to prevent camera from unexpected drop and connect Main Body Cable to Main Body Connector in Wall Mount Bracket.

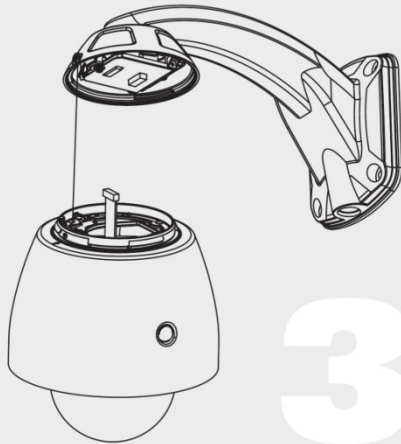

④ Line up the mold lines and assemble main body to Wall Mount Bracket.

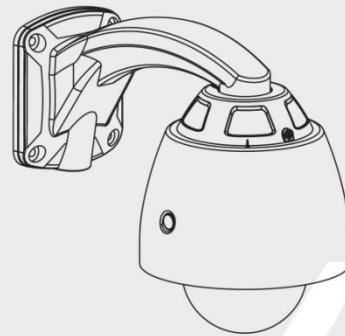

⑤ Turn main body on its axis in CW(Clockwise) direction and, after assembling them, screw main body to Wall Mount Bracket to protect them from separation by vibration or others.

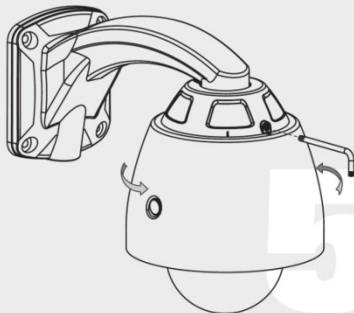

⑥ In case of using pipe, use the hole located on lower side of Wall Mount Bracket to fix pipe.

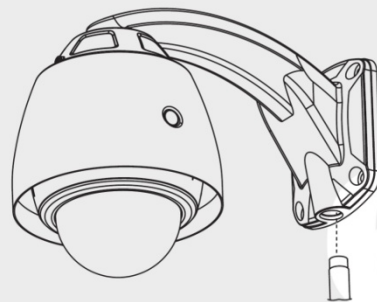

2. Installation

⊙ Installation Using the Pendant Mount

① To pass cables to upside of ceiling, please make a hole with 50~60mm diameter on the ceiling panel and attach the Ceiling mount bracket on it.

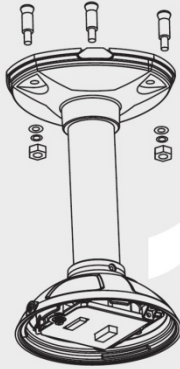

② Wire cables to terminal blocks on the PCB in Ceiling Mount Bracket.



③ Hook up "Drop Prevention Spring" on main body to prevent camera from unexpected drop and connect Main Body Cable to Main Body Connector in Ceiling Mount Bracket.

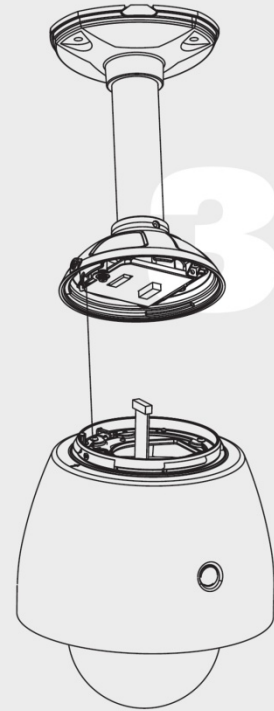

④ Line up the mold lines and assemble main body to Ceiling Mount Bracket.

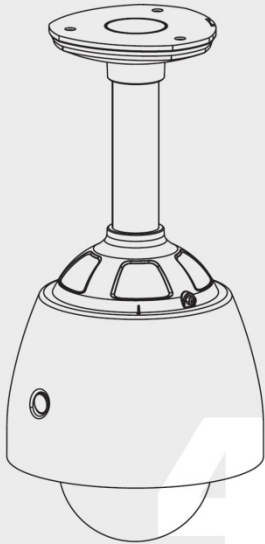

⑤ Turn main body on its axis in CW (Clockwise) direction and, after assembling them, screw main body to Ceiling Mount Bracket to protect them from separation by vibration or others.

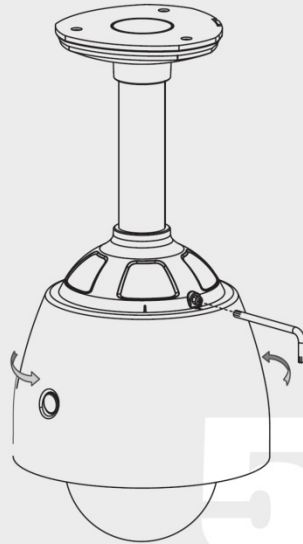

2. Installation

○ Wire Connections

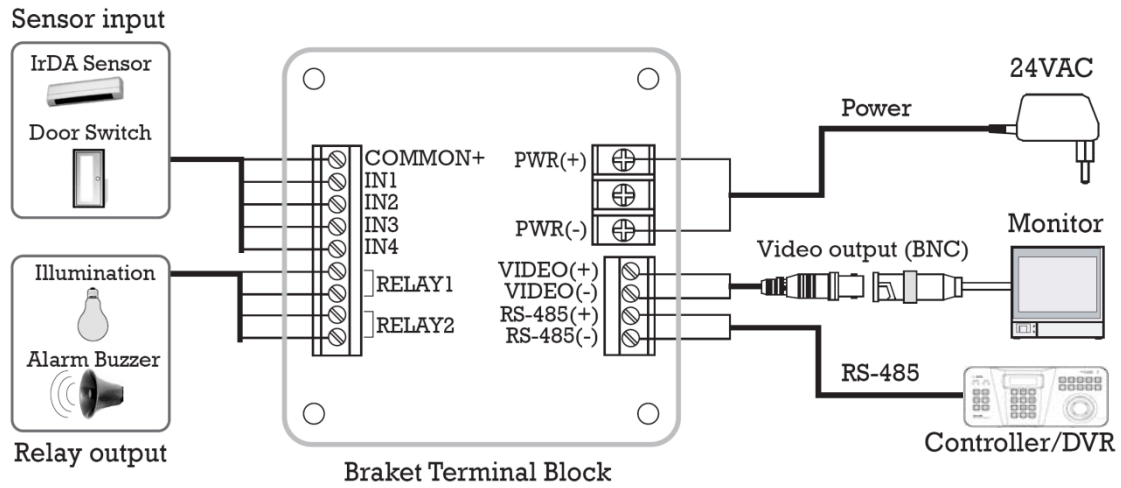

■ Power Connection

- The standard power for the system is 24VAC / 2A.
Please, check the voltage and current capacity of rated power carefully.

■ Video Connection

- Connect With BNC coaxial cable.

■ RS-485 Communication

- For PTZ control, connect this line to keyboard and DVR. To control multiple cameras at the same time, RS-485 communication lines of them is connected in parallel as shown below.

Keyboard Controller / DVR

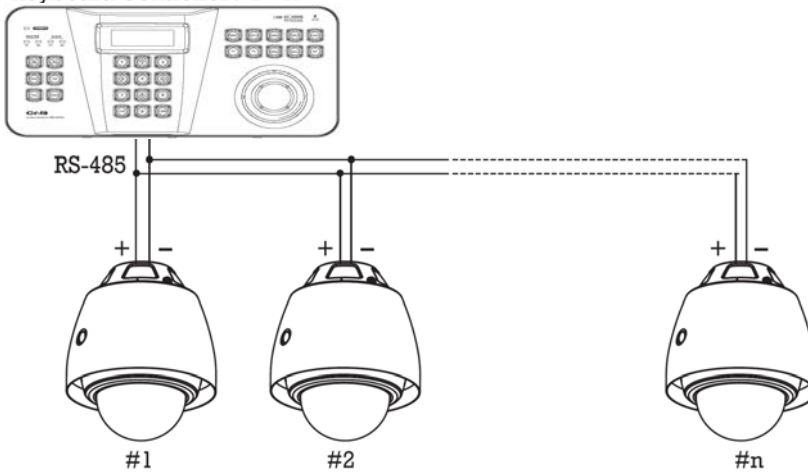

2. Installation

■ Sensor Input/Relay Output

• Sensor input connection

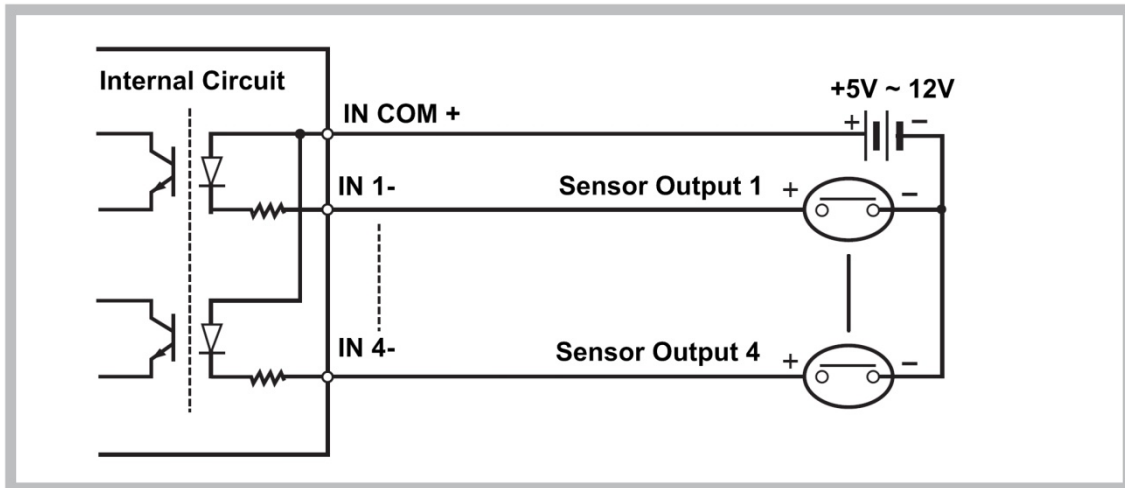

Before connecting sensors, check driving voltage and output signal type of the sensor.

Since output signal types of the sensors are divided into Open Collector and Voltage Output type in general, the cabling must be done properly after considering these types.

Also, the sensor type, i.e. "Normal Open" or "Normal Close" in DIP switch in main body of camera must be set properly.

Signal Line	Description
IN COM+	Connect(+)cable of electric power source for sensors to this port as shown in the circuit above.
IN1 -, IN2 -, IN3 -, In4 -	Connect output of sensors for each port as shown in the circuit above.

• Relay output connection

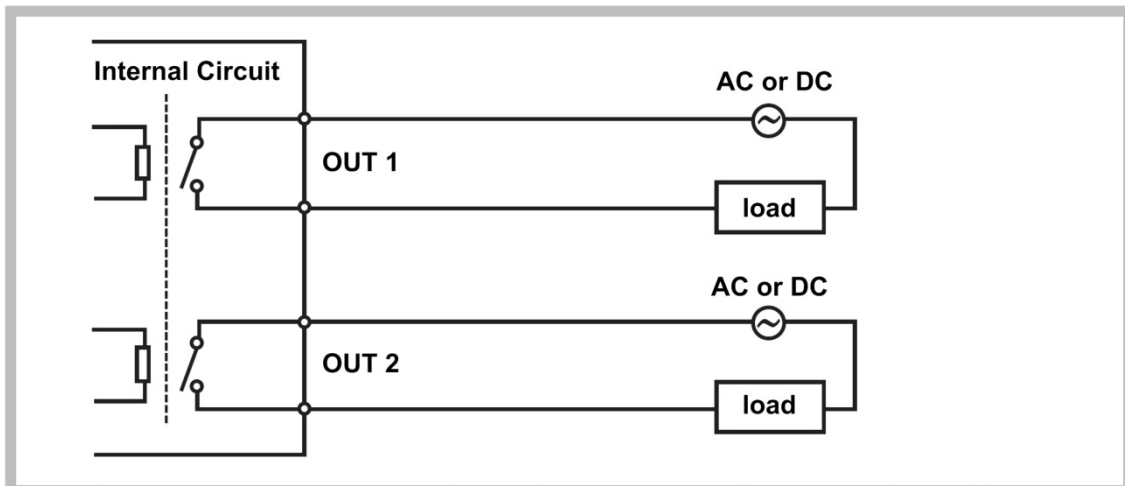

Maximum allowable electrical load of relay is shown below table.

Driving Power	DC	110VAC	220VAC
Max. Capacity	28VDC, 3A	110VAC, 3A	250VAC, 3A

3. Operation

⊙ Check Points before Operation

- Before power is applied, please check the cables carefully.
- The camera ID of the controller must be identical to that of the target camera.
The camera ID can be checked by reading DIP switches of the camera.
- If your controller supports multi-protocols, the protocol must be changed to match to that of the camera.
- If you changed camera protocol by changing DIP switches, the change will be effective after you reboot the camera.
- Since the operation method can be different for each controller available, refer to the manual for your controller if camera can not be controlled properly. The operation of this manual is based on the standard Pelco Controller.

⊙ Preset and Pattern Function Pre-Check

- Check how to operate preset and pattern function with controller or DVR in advance to operate camera function fully when using controller or DVR.
- Refer to the following table when using standard Pelco protocol controller.

<Go Preset>	Input[Preset Number] and press [Preset] button shortly.
<Set Preset>	Input[Preset Number] and press [Preset] button for more than 2 seconds.
<Run Pattern>	Input[Pattern number] and press [Pattern] button shortly.
<Set Pattern>	Input[Preset Number] and press [Pattern] button for more than 2 seconds.

- If controller or DVR has no pattern button or function, use shortcut keys with preset numbers. For more information, refer to "Reserved Preset" in this manual.

⊙ Starting OSD Menu

- Function : Using the OSD menu, Preset, Pattern, Swing, Group and Alarm I/O function can be configured for each application.
- Enter Menu : <Go Preset> [95]

⊙ Reserved Preset

- Description Some Preset numbers are reserved to special functions.
- Function 1. <Go Preset> [95] : Enters into OSD menu
 2. <Go Preset> [131-134] : Runs pattern function 1~4
 3. <Go Preset> [141~148] : Runs Swing Function 1~8
 4. <Go Preset> [151~158] : Runs Group Function 1~8

3. Operation

⊖ Preset

- **Function** Max. 127 positions can be stored as Preset position. The Preset number can be assigned from 1 to 128, but 95 is reserved for starting OSD menu.
Camera characteristics (i.e. White Balance, Auto Exposure) can be set up independently for each preset. Label should be blank and Relay Outputs should be set to OFF as default. "Camera Adjust" should be set "GLOBAL" as default. All characteristics can be set up in OSD menu.
- **Set Preset** <Set Preset> [1~128]
- **Run Preset** <Go Preset> [1~128]
- **Delete Preset** To delete Preset, use OSD menu

⊖ Swing

- **Function** By using Swing function, you can make camera to move between 2 Preset positions repeatedly.
When swing function runs, camera moves from the preset assigned as the 1st point to the preset assigned as the 2nd point in CW(Clockwise) direction. Then camera moves from the preset assigned as the 2nd point to the preset assigned as the 1st point in CCW(Counterclockwise) direction.

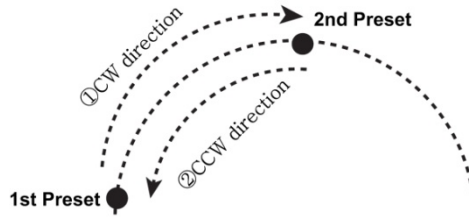

In case that the preset assigned as the 1st point is same as the preset assigned as the 2nd point, Camera turns on its axis by 360° in CW(Clockwise) direction and then it turns on its axis by 360° in CCW(Counterclockwise) direction. Speed can be set up from 1°/sec to 180°/sec

- **Set Swing** To set Swing, use OSD menu
- **Run Sing** Method 1) <Run Pattern> [Swing NO.+10] → ex) Run Swing 3 : <Run Pattern>[13]
Method 2) <Go Preset> [Swing NO.+140] → ex) Run Swing 3 : <Go Preset>[143]
- **Deleting Swing** To delete Swing, use OSD menu.

⊖ Pattern

- **Function** Pattern Function is that a camera memorizes the path (mostly curve path) by joystick of controller and preset move functions for assigned time and revives the path exactly as it memorized.
4 Patterns are available and Maximum 1200 communication commands can be stored in a pattern.

- **Setting Pattern** Pattern can be created by one of following two methods.

Method 1) <Set Pattern> [Pattern NO.]

- Pattern editing screen is displayed as bellow.
- Movement by Joystick and preset movement can be memorized in a pattern.
- The rest memory size is displayed in progress bar.
- To save the recording, press **NEAR** key and to cancel, press **FAR** key.

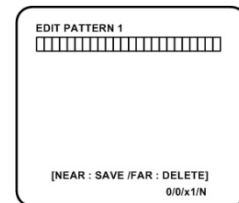

Method 2) Using OSD Menu : See the section "how to use OSD Menu".

- **Run Pattern** Method 1) <Run Pattern>[Pattern NO.] → ex) Run Pattern 2 : <Run Pattern>[2]
Method 2) <Go Preset>[Pattern NO.+130] → ex) Run Pattern 2 : <Go Preset>[132]
- **Delete Pattern** Use OSD menu to delete a Pattern.

3. Operation

⊖ Group

- **Function** The group function allows running sequence of Presets, Pattern and/or Swings. Max. 8 group can be stored. Each group can have max. 20 action entities which can be preset, pattern or swing. Preset speed can be set up and the repeat number of pattern & Swing can be set up in Group setup. Dwell time between actions can be set up also.

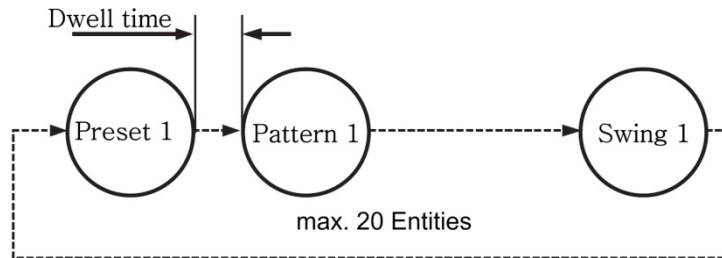

- **Setting Group** Use OSD Menu to create a Group.
- **Run Group**
 - 1) <Run Pattern>[Group No.+20] → ex)Run Group7 : <Run Pattern>[27]
 - 2) <Go Preset>[Group No.+150] → ex)Run Group7 : <Go Preset>[157]
- **Deleting Group** Use OSD Menu to delete.

⊖ Other Functions

- **Power Up Action** This function enables to resume the last action executed before power down. Most of actions such as Preset, Pattern, Swing and Group are available for this function but Jog actions are not available to resume.
- **Auto Flip** In case that tilt angle arrives at the top of tilt orbit(90°), the zoom module camera pans 180° to keep tracing targets. If this function is set to OFF, tilt movement range is 0~95°
- **Park Action** This function enables to locate the camera to specific position automatically if operator doesn't operate the controller for a while. The park Time can be defined as an interval from 1 minute to 4 hours.
- **Alarm I/O** 4 Alarm Inputs and 2 Alarm Outputs (Relay output) are used. If an external sensor is activated, camera can be set to move to corresponding preset position. Also, the output relay can be matched to some specific preset positions to do counteractions such as turning on the light or sounding the alarm. It is noted that the latest alarm input is effective if multiple sensors are activated.
- **Privacy Zone Mask** To protect privacy, Max. 8 Privacy Masks can be created on the arbitrary position to hide objects such as windows, shops or private house. With Spherical Coordinates system, powerful Privacy Zone Mask function is possible. This function is only available with S2465N(P)X, S2665N(P)X, S2965N(P)X and SCN-22Z27F /SCN-23Z27F(P)(Option).
- **Global/Local Image Setup** WB(White Balance) and AE(Auto Exposure) can be set up independently for each preset. There are 2 modes, "Global" mode & "Local" Mode. The Global mode means that WB or AE can be set up totally and simultaneously for all presets in "ZOOM CAMERA SETUP" menu. The Local mode means that WB or AE can be set up independently or separately for each preset in each preset setup menu. Each Local WB/AE value should activate correspondingly when camera arrives at each preset location. During jog operation, Global WB/AE value should be applied. All Local WB/AE value do not change although Global WB/AE value changes.
- **SemiAuto Focus** This mode exchanges focus mode automatically between Manual Focus mode and Auto focus mode by operation. Manual Focus mode activates in preset operation and Auto Focus mode activates during jog operation. With Manual mode at preset, Focus data is memorized in each preset in advance and camera calls focus data in correspondence with presets as soon as camera arrives at a preset. It should shorten time to get focuses. Focus mode changes to Auto Focus mode automatically when jog operation starts.

4. OSD Menu

⊙ OSD Display of Main Screen

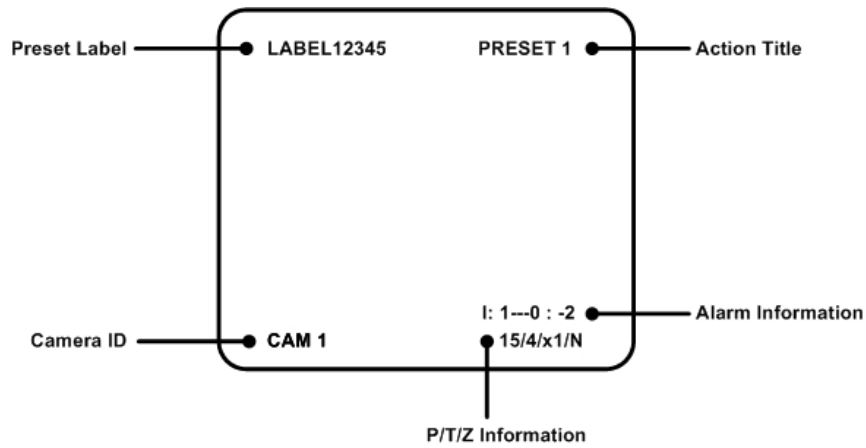

- **P/T/Z Information** Current Pan/Tilt angle in degree, zoom magnification and a compass direction.
- **Camera ID** Current Camera ID (Address).
- **Action Title**

Followings are possible Action Titles and their meaning.

"SET PRESET xxx"	→	When Preset xxx is stored
"PRESET xxx"	→	When camera reach to preset xxx
"PATTERN x"	→	When Pattern x is in action
"SWGx/PRESET xxx"	→	When Swing x is in action
"UNDEFINED"	→	When undefined function is called to run
- **Preset Label** The Label stored for specific Preset.
- **Alarm Information**

This information shows current state of sensor input and relay output.
 If the Input and output points are ON state it will show a number corresponding to each point
 When they are OFF state, '-' will be displayed.
 Ex) point 2&3 of inputs and 1 of output are ON, OSD will show as below



4. OSD Menu

⊖ General Rules of key Operation for Menu

- The menu items surrounded with < > always has its sub menu.
- For all menu level, to go into sub menu, press **NEAR** key.
- To go to up-one-level menu, press **FAR** key.
- To move from items to item in the menu, use joystick in the **Up/Down** or **Left/Right**.
- To change a value of an item, use **Up/Down** of the joystick in the controller.
- Press **NEAR** key to save values and Press **FAR** key to cancel values.
- Specifications and functions should be different by models.

⊖ Main Menu

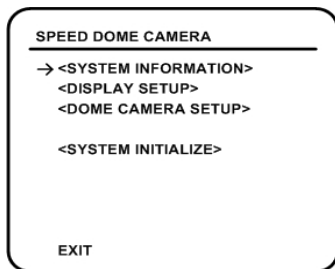

- **SYSTEM INFORMATION** Displays system information and configuration.
- **DISPLAU SETUP** Enable/Disable of OSD display on Main Screen.
- **DOME CAMERA SETUP** Configure various functions of this camera.
- **SYSTEM INITIALIZE** Initializes system configuration and sets all data to factory default configuration.

⊖ Display Setup

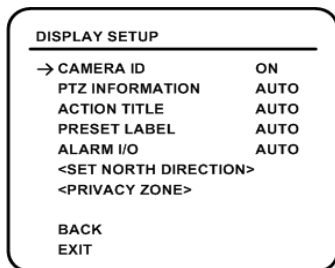

This menu defines Enable/Disable of OSD display on main Screen,
If an item is set to be AUTO, the item is displayed only when the value of it is changed.

- **CAMERA ID** [ON/OFF]
- **PTZ INFORMATION** [ON/OFF/AUTO]
- **ACTION TITLE** [ON/OFF/AUTO]
- **PRESET LABEL** [ON/OFF/AUTO]
- **ALARM I/O** [ON/OFF/AUTO]

■ COMPASS DIRECTION SETUP

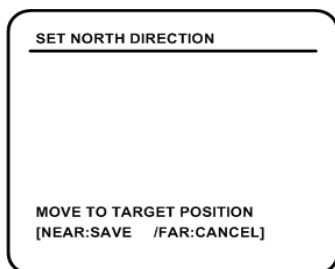

Set North to assign compass direction as criteria.
Move camera and press **NEAR** button to save.

4. OSD Menu

○ Privacy Zone Mask Setup

(Models S2465N(P)X, S2965N(P)X, SCN-22Z27F /SCN-23Z27F (Option) Only)

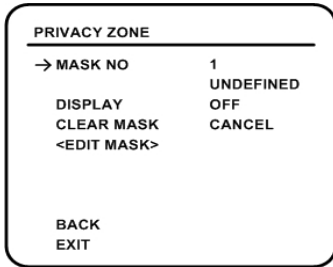

Select area in image to mask.

- **MASK NO** [1~8]
Select Mask number. If the selected mask has already data, camera moves as it was set. Otherwise, "UNDEFINED" will be displayed under "MASK NO".
- **DISPLAY** [ON/OFF]
Sets if camera makes mask shows or not on images.
- **CLEAR MASK** [CANCEL/OK]
Deletes data in the selected mask NO.

■ Privacy Zone Area Setup

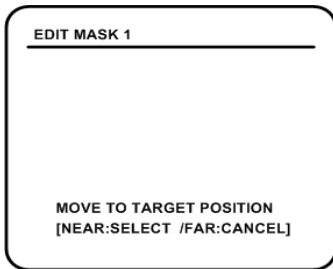

Move camera to the area to mask.
Then the menu to adjust mask size will be displayed.

■ Privacy Zone Size Adjustment

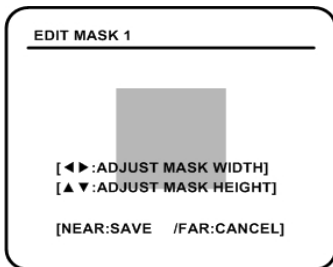

Adjust mask size, Use joystick or arrow buttons to adjust mask size.

- **<Left/Right>** Adjusts mask width.
- **<Up/Down>** Adjusts mask height.

4. OSD Menu

○ Camera Setup (Model SCN-22Z27F /SCN-23Z27F)

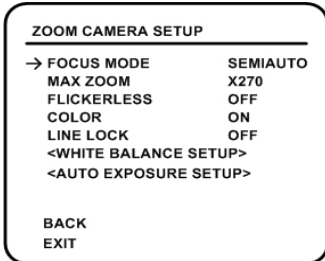

Setup the general functions of 27x optical zoom camera module.

- **FOCUS MODE** [AUTO/MANUAL/SEMAUTO]
Sets camera focus mode.
- **MAX ZOOM** [x1 ~ x270]
Sets the maximum zoom magnification.
- **FLICKERLESS** [ON/OFF]
When an NTSC camera if used under 50Hz and PAL under 60Hz flickering may appear on the screen. When this happens, turn FLICKERLESS setting ON. This prevents flickering which happens when the frequency of the power and the frequency of camera are different. When FLICKERLESS in ON, Day&Night mode goes DAY and Digital Slow Shutter mode goes OFF automatically.
- **COLOR** [ON/OFF]
Switching color mode to black-white mode
- **LINE LOCK** [ON/OFF]
If Line lock sync is ON, video signal is synchronized with AC power. Video can be fluctuated after setting is changed.

■ WHITE BALANCE SETUP

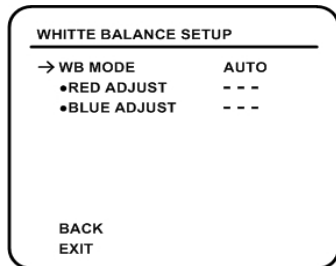

- **WB MODE** [AUTO/MANUAL]
In Manual mode, Red and Blue level can be setup manually.
- **RED ADJUST** [0~255]
- **BLUE ADJUST** [0~255]

4. OSD Menu

■ AUTO EXPOSURE SETUP

AUTO EXPOSURE SETUP	
→ BACKLIGHT	OFF
DAY/NIGHT	AUTO
SLOW SHUTTER	OFF
AE MODE	AUTO
•IRIS LEVEL	---
•GAIN LEVEL	---
•SHUTTER SPD	---
BRIGHTNESS	50
BACK	
EXIT	

- **BACKLIGHT** [OFF/C1/C2/L1/L2/U1/U2/D1/D2/R1/R2]
Sets Backlight Compensation.
The reference position and the level of BLC are selectable. Refer to the table below. *Note1)*
- **DAY/NIGHT** [AUTO/DAY/NIGHT]
- **SLOW SHOUTTER** [OFF/2~128 Field]
Activates SLOW SHUTTER function when luminance of image(signal) is too dark. It is possible to set up the maximum number of fields piled up one on another by SLOW SHUTTER function. It is only available when DAY/NIGHT mode is DAY [AUTO/SHUTTER/IRIS/AGC/MANUAL]
There are five modes of Auto Exposure function.
Except AUTO mode, the others can be selected when DAY/NIGHT mode is DAY and Slow Shutter mode is OFF.
- **AE MODE** [0~255]
It can be set when AE is in IRIS mode or MANUAL mode.
- **IRIS LEVEL** [0~255]
It can be set when AE is in AGC mode or MANUAL mode.
- **GAIN LEVEL** [0~27]
It can be set when AE is in SHUTTTER SPEED mode or in MANUAL mode. As for setting value, refer to the table below. *Note2)*
- **SHUTTER SPEED** [0~96]
It can be set when AE is not in MANUAL mode.

Note1) Backlight Compensation

Value	Description	Value	Description
C1	Low weight at the center of the screen	C2	High weight at the center of the screen
L1	Low weight at the left of the screen	L2	High weight at the left of the screen
U1	Low weight at the upper of the screen	U2	High weight at the upper of the screen
D1	Low weight at the lower of the screen	D2	High weight at the lower of the screen
R1	Low weight at the right of the screen	R2	High weight at the right of the screen

Note2) Shutter Speed Table

*The values are based on NTSC type models.

Value	Shutter	Value	Shutter	Value	Shutter	Value	Shutter
0	1/60 sec	7	1/400 sec	14	1/1000 sec	21	1/2500 sec
1	1/125 sec	8	1/450 sec	15	1/1100 sec	22	1/2500 sec
2	1/150 sec	9	1/500 sec	16	1/1300 sec	23	1/3000 sec
3	1/200 sec	10	1/600 sec	17	1/1500 sec	24	1/3500 sec
4	1/250 sec	11	1/700 sec	18	1/1600 sec	25	1/4000 sec
5	1/300 sec	12	1/800 sec	19	1/1800 sec	26	1/6000 sec
6	1/350 sec	13	1/900 sec	20	1/2000 sec	27	1/10000 sec

4. OSD Menu

☉ Camera Setup (Models S2465N(P)X, S2965N(P)X)

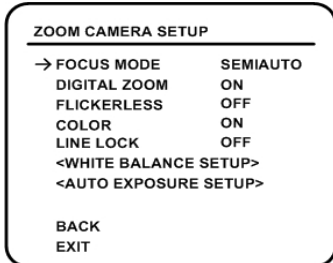

Setup the general functions of 26x / 36x optical zoom modules.

- **FOCUS MODE** [AUTO/MANUAL/SEMIAUTO]
Sets camera focus mode.
- **DIGITAL ZOOM** [ON/OFF]
Sets digital zoom on or off.
- **FLICKERLESS** [ON/OFF]
When an NTSC camera is used under 50Hz or PAL under 60Hz, flickering may appear on the screen.
When this happens, turn Flickerlees setting ON.
This prevents flickering which happens when the frequency of the power and the frequency of camera are different.
- **COLOR** [ON/OFF]
Switching color mode to black-white mode.
- **LINE LOCK** [ON/OFF]
If Line lock sync is ON, video signal is synchronized with AC power. Video can be fluctuated after setting is changed.

■ WHITE BALANCE SETUP

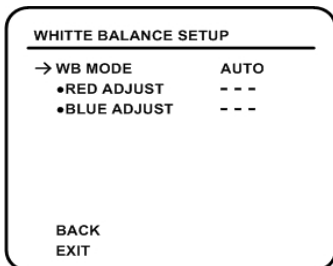

- **WB MODE** [AUTO/MANUAL]
In Manual mode, Red and Blue level can be setup manually.
- **RED ADJUST** [0~255]
- **BLUE ADJUST** [0~255]

4. OSD Menu

■ AUTO EXPOSURE SETUP

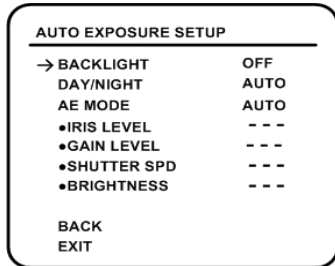

- **BACKLIGHT** [ON/OFF]
Sets Backlight Compensation.
- **DAY/NIGHT** [AUTO/DAY/NIGHT]
- **AE MODE** [AUTO/SHUTTER/IRIS/GAIN/BRIGHT/MANUAL]
Selects automatic exposure mode. Each mode appears with adjustable values. When Flickerless mode is ON, AE mode is automatically in SHUTTER SPEED mode.
- **IRIS LEVEL** [CLOSE/F1.6~F28] (Model S1465N(P)X, S1965N(P)X)
[CLOSE/F1.4~F22] (Model S1665N(P)X)
It can be set when AE is in IRIS mode or MANUAL mode.
- **GAIN LEVEL** [-3dB~28dB]
It can be set when AE is in MANUAL mode.
- **SHUTTER SPEED** [1/1sec~1/10000sec]
It can be set when AE is in SHUTTER SPEED mode or MANUAL mode.
- **BRIGHTNESS** [0~31]
It can be set when AE is in BRIGHTNESS mode.
- **WDR** Only available with S1965N(P)X Models.

4. OSD Menu

⊙ Motion Setup

MOTION SETUP	
→ MOTION LOCK	OFF
PWR UP ACTION	ON
AUTO FLIP	ON
JOG MAX SPEED	120/SEC
JOG DIRECTION	INVERSE
FRZ IN PRESET	OFF
<PARKING ACTION SETUP>	
<ALARM INPUT SETUP>	
BACK	
EXIT	

Setup the general functions of Pan/Tilt motions.

- **MOTION LOCK** [ON/OFF]
If Motion Lock is set to ON, it is impossible to set up and delete Preset Swing, Pattern and Group.
It is possible only to run those functions. To set up and delete those functions, enter into OSD menu.
- **PWR UP ACTION** [ON/OFF]
Refer to "Other Functions" section.
- **AUTO FLIP** [ON/OFF]
Refer to "Other Functions" section.
- **JOG MAX SPEED** [1°/sec~360°/sec]
Sets maximum jog speed. Jog speed is inversely proportional to zoom magnification. As zoom magnification goes up, pan/tilt speed goes down.
- **JOG DIRECTION** [INVERSE/NORMAL]
If you set this to 'Inverse', the view in the screen is moving same direction with jog tilting. If 'Normal' is selected, the view in the screen is moving reversely.
- **FRZ IN PRESET** [ON/OFF] (27x, 36x Models Only)
If "Freeze in preset" function mode is ON, camera starts freezing the image of start point at start point of preset movement. Camera keeps displaying the image of start point during preset movement and does not display the images which camera gets during preset movement. As soon as camera stops at preset end point, camera start displaying live images which it gets at preset end point.
This function is only available with 27x, 36x Models.

■ PARK ACTION SETUP

PARKING ACTION SETUP	
→ PARK ENABLE	OFF
WAIT TIME	00:10:00
PARK ACTION	HOME
BACK	
EXIT	

If Park Enable is set to ON, camera runs assigned function automatically if there is no PTZ command during assigned "Wait Time".

- **PARK ENABLE** [ON/OFF]
- **WAIT TIME** [1 minute ~ 4 hours]
The time is displayed with "hh:mm:ss" format and you can change this by 1 min unit.
- **PARK ACTION** [HOME/PRESET/PATTERN/SWING/GROUP]
If it is set to "HOME", all the functions go back to "HOME" position (PAN,TILT,ZOOM)=(0, 0, x1).

4. OSD Menu

■ ALARM ACTION SETUP

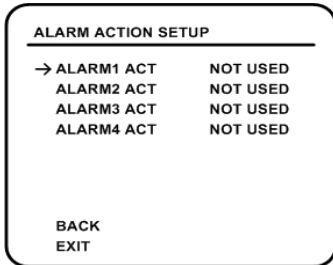

Sets the preset to move to when the alarm is input.

- **ALARM N ACT** [NOT USED/PRESET 1~128]
Assign counteraction Preset position to each Alarm input

The uppercase "N" indicates the alarm index.

⊙ Preset Setup

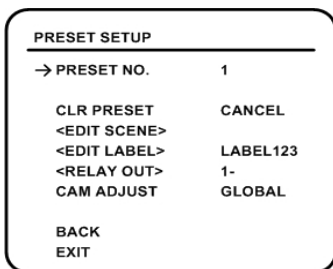

- **PRESET NO.** [1~128]
If a selected preset is already defined, camera moves to pre-defined position and preset characteristics such as Label and Relay Outputs show on monitor. If a selected preset is not defined, "UNDEFINED" shows on monitor.
- **CLR PRESET** [CANCEL/OK]
Delete current Preset data.
- **EDIT SCENE**
Redefine current Preset scene position (i.e.PTZ).
- **EDIT LABEL**
Edits Label to show on monitor when preset runs.
MAX. 10 alphabets are allowed.
- **RELAY OUT**
Sets the relay output. The figure on the right is current Setting value. '1' indicates OFF mode.
If the relay is shown as figures, it means relay is ON.
- **CAM ADJUST** [GLOBAL/LOCAL]
WB(White Balance) and AE(Auto Exposure) can be set up independently for each preset. There are 2 modes, "Global" mode & "local" mode.
The Global mode means that WB or AE can be set up totally and simultaneously for all presets in "ZOOM CAMERA SETUP" menu.
The local mode means that WB or AE can be set up independently or separately for each preset in each preset setup menu. Each Local WB/AE value should activate correspondingly when camera arrives at each preset location.
During jog operation, Global WB/AE value should be applied.
All Local WB/AE value should not change although Global WB/AE value changes. If "local" is selected, Menu to set WB/AE shows on monitor.

4. OSD Menu

■ EDIT PRESET SCENE

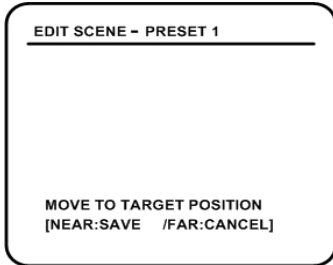

- ① Using Joystick, move camera to desired position.
- ② By pressing **NEAR** key, save current PTZ data.
- ③ Press **FAR** key to cancel.

■ EDIT PRESET LABEL

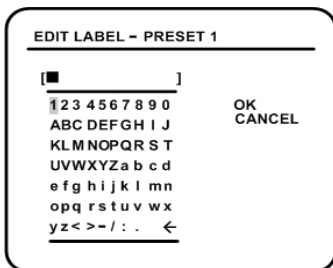

- ① Edits label to show on monitor when camera arrives at presets.
In Edit label menu, a reverse rectangular is cursor.
As soon as finishing selecting alphabet, cursor moves to the next digit.



- ② Using **Left/Right/Up/Down** of joystick, move to an appropriate character from the Character set.
To choose that character, press the **NEAR** key.

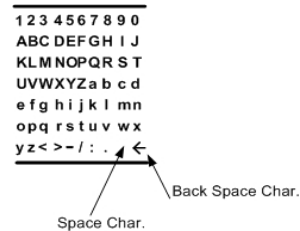

If you want to use blank, choose Space character(" "). If you want To delete a character before, use back space character(" ← ").

- ③ If you complete the Label editing, move cursor to "OK" and press **NEAR** key to save completed label. To abort current change, move cursor to "Cancel" and press **NEAR** key.

■ EDIT RELAY OUT

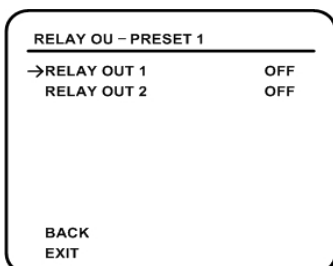

- **RELAY OUT N** [ON/OFF]
Sets relay output when changing preset position.

The uppercase "N" indicates the number for the preset.

4. OSD Menu

⊙ Swing Setup

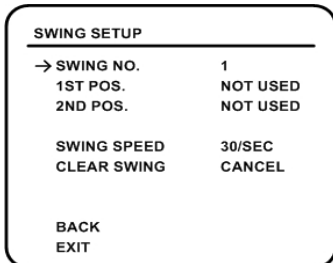

• **SWING NO.** [1~8]
Selects Swing number to edit. If a selected Swing has not defined, "NOT USED" is displayed in 1st Position and 2nd Position.

• **1ST POS.** [PRESET 1~128]
• **2ND POS.** Set up the 2 position for Swing function.
If a selected preset is not defined, "UNDEFINED" will be displayed as shown below.

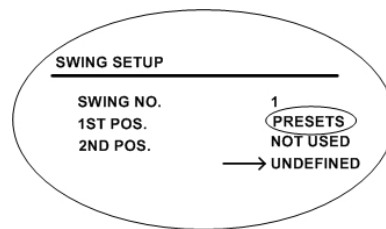

When swing function runs, camera moves from the preset assigned as the 1st point to the preset assigned as the 2nd point in CW(Clockwise) direction. Then camera moves from the preset assigned as the 2nd point to the preset assigned as the 1st point is CCW(Counterclockwise) direction.
In case that the preset assigned as the 1st point is same as the preset assigned as the 2nd point, camera turns on its axis by 360° in CW direction and then it turns on its axis by 360° in CCW direction.

• **SWING SPEED** [1°/sec~180°/sec]
Sets Swing speed from 1°/sec to 180°/sec.

• **CLEAR SWING** [CANCEL/OK]
Deletes current Swing data.

4. OSD Menu

○ Pattern setup

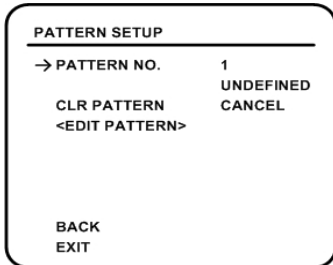

- **PATTERN NO.** [1~4]
Selects Pattern number to edit. If a selected pattern number is not defined, "UNDEFINED" will be displayed under selected pattern number.
- **CLR PATTERN** [CANCEL/OK]
Deletes data in current pattern.
- **EDIT PATTERN** Starts editing pattern.

■ EDIT PATTERN

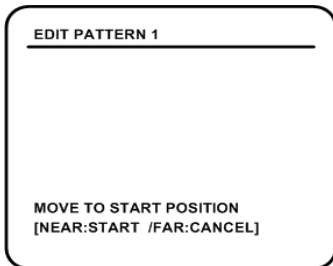

- ① By using Joystick, move to start position with appropriate zoom.
To start pattern recording, press **NEAR** key. To exit this menu, press **FAR** key.

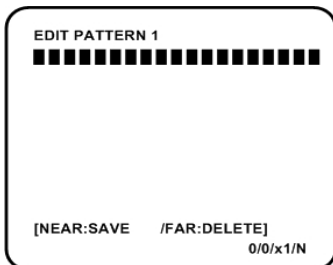

- ② Move camera with joystick of controller or run preset function to memorize the path (mostly curve path) in a selected pattern. The total memory size and the rest memory size is displayed in the form of bar.
Maximum 1200 communication commands can be stored in a pattern.
- ③ To save data and exit, press **NEAR** key. To cancel recording and delete record data, press **FAR** key.

4. OSD Menu

① Group Setup

GROUP SETUP	
→ GROUP NO.	1 UNDEFINED
CLEAR GROUP	CANCEL
<EDIT GROUP>	
BACK	
EXIT	

- **GROUP NO.** [1~8]
Selects a group number. If the selected number is not set, "UNDEFINED" will be displayed selected Group number.
- **CLEAR GROUP** [CANCEL/OK]
Clears the current setting of a group.
- **EDIT GROUP** Starts editing Group.

■ EDIT GROUP

EDIT GROUP 1				
→NO	ACTION	###	DWELL	OPT
1	NONE			
2	NONE			
3	NONE			
4	NONE			
5	NONE			
SAVE				
CANCEL [NEAR:EDIT]				

① Press **NEAR** key in "NO" list to start Group setup.

EDIT GROUP 1				
NO	ACTION	###	DWELL	OPT
→1	NONE			
2	NONE			
3	NONE			
4	NONE			
5	NONE			
SAVE [NEAR:EDIT ACT]				
CANCEL [FAR :EDIT END]				

② Note that MAX. 20Functions are allowed in a Group. Move cursor up/down and press **NEAR** key to set up.

EDIT GROUP 1				
NO	ACTION	###	DWELL	OPT
1	NONE			
2	NONE			
3	NONE			
4	NONE			
5	NONE			
SAVE [◀▶:MOVE CURSOR]				
CANCEL [▲▼:CHANGE VAL.]				

③ Set up Action, Dwell time and Option. Note that selected item is displayed in reverse. Move cursor **Left/Right** to select items and move cursor **Up/Down** to change each value.

- **ACTION ###** [NONE/PRESET/SWING/PATTERN]
- **DWELL** [0 sec~4min]
Sets Dwell Time between functions.
- **OPT (Option)** It should be preset speed when preset is set in Action.
It should be the number of repeat when Pattern or Swing is selected in Action.

4. OSD Menu

EDIT GROUP 1				
NO	ACTION	###	DWELL	OPT
1	PRESET	1	00:03	360
2	NONE			
3	NONE			
4	NONE			
5	NONE			

SAVE [◀▶:MOVE CURSOR]
CANCEL [▲▼:CHANGE VAL.]

④ Set up items such as Action, ###, Dwell and OPT

EDIT GROUP 1				
NO	ACTION	###	DWELL	OPT
→1	PRESET	1	00:03	360
2	NONE			
3	NONE			
4	NONE			
5	NONE			

SAVE [NEAR:EDIT ACT]
CANCEL [FAR :EDIT END]

⑤ After finishing setting up a Action, press **NEAR** key to one-upper-Level Menu(Step②).
Move cursor **Up/Down** to select Action Number and repeat Step ②~ Step ④ to edit selected Group.

EDIT GROUP 1				
NO	ACTION	###	DWELL	OPT
1	PRESET	1	00:03	360
2	NONE			
3	NONE			
4	NONE			
5	NONE			

→SAVE
CANCEL

⑥ After Finishing setting up all Action, press **FAR** key to exit.
Then cursor should be moved to "SAVE". Press **NEAR** key to save data.

4. OSD Menu

⊙ System Initialize

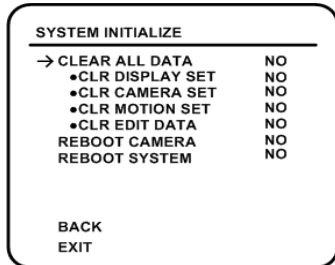

- **CLEAR ALL DATA** Deletes all configuration data such as display, camera, motion setup and so on.
- **CLR DISPLAY SET** Initializes Display Configuration.
- **CLR CAMERA SET** Initializes camera Configuration.
- **CLR MOTION SET** Initializes Motion Configuration.
- **CLR EDIT DATA** Deletes Preset Data, Swing Data, Pattern Data and Group Data.
- **REBOOT CAMERA** Reboots Zoom Camera module.
- **REBOOT SYSTEM** Reboots Speed Dome Camera.

■ Initial setting

• Display setting		• Camera setting	
Camera ID	ON	Focus mode	SemiAuto
PTZ Information	AUTO	Digital Zoom ♣●	ON
Action Title	AUTO	Max Zoom	X216
Preset Label	AUTO	Flickerless	X270 ▣ / x312 ♣ / x432 ●
Alarm I/O	AUTO	Color	OFF
North Direction	Pan 0 °	Line Lock	ON
Privacy Zone ♣●▣	Undefined	White Balance	OFF
		Backlight	AUTO
		Day&Night	OFF
		Slow Shutter ▣	AUTO
		AE Mode	OFF
		Brightness ▣	AUTO
			50
• Motion setting		• User setting data	
Motion Lock	OFF	Preset 1~128	Undefined
Power up Action	ON	Swing 1~8	Undefined
Auto Flip	ON	Pattern 1~4	Undefined
Jog Max Speed	120 °/sec	Group 1~8	Undefined
Jog Direction	INVERSE		
Park Action	OFF		
Alarm Action	OFF		
FRZ IN PRESET ●▣	OFF		

■ Above functions are only available with the following models;

♣ : S2465N(P)

● : S2965N(P)X

▣ : SCN-22Z27F /SCN-23Z27F(P)(Option)

5. Specifications

☉ 26x EXview Models S2465NX / S2465PX

Video Signal		NTSC	PAL
Camera	Image Pick-up Device	1/4" EXview HAD CCD	
	Effective Pixels	768(H) x 494(V) 380K	752(H) x 582(V) 440K
	Horizontal Resolution	470 TV Lines	460 TV Lines
	S/N Ratio	More than 50 db	
	Zoom	26x Optical Zoom, 12x Digital Zoom	
	Focal Length	f=3.5(Wide)-91(Tele)mm	
	Aperture Range	F1.6(Wide)-3.8(Tele)	
	Minimum Illumination	1.0Lux (Color) / 0.07Lux (Color, DSS) / 0.15 Lux (B/W,DSS)	
	Day & Night	Auto / Day /Night (IR Cut Filter)	
	Focus	Auto / Manual / SemiAuto	
	AE Mode	Auto / Iris / Shutter / Manual / Brightness	
	White Balance	Auto / Manual(Red, Blue Gain Adjustable)	
	BLC	On / Off	
	Flickerless	On / Off	
Pan/Tilt	Operation Range	Pan 360 ° (Endless) / Tilt 90 °	
	Operation Speed	Preset : 360 ° / sec	
		Manual : 1 ~ 360 ° / sec (inter-locked with zoom extension)	
		Swing : 1 ~ 180 ° /sec	
	Preset Setting	127 presets (label setting, individual video setting)	
	Swing Setting	8 swings	
	Pattern Setting	4 pattern (1200 commands / pattern, 5 min)	
	Group Setting	8 groups (20 actions / group)	
Other Functions	Auto Flip, Auto Parking, Power Up Action		
General	Communication	RS-485	
	Protocol	Pelco-D, Pelco-P, Samsung and Panasonic Selectable	
	Privacy Zone	8 Zones	
	Alarm I/O	4 inputs / 2 outputs	
	OSD Menu	On / Off	
	Input Voltage	24VAC (19VAC ~ 29VAC)	
	Input Power	48VA	
	Fuse	2A	
	Dimension	Dome Ø 149	
		Housing : Ø 209.7 x 247.2(H) mm (without Sun-Sheild)	
	Weight(Approx.)	3.8kg (without Sun-Sheild) / 4.3kg (with Sun-Sheild)	
Operational Temperature	-30 °C ~ +50 °C		

■ Types by installation



Pendant Mount



Pendant Mount (Sun-Shield)

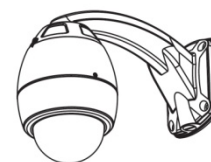

Wall Mount

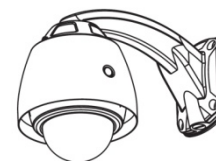

Wall Mount (Sun-Shield)

5. Specifications

27x Models SCN-22Z27F /SCN-23Z27F

Video Signal		NTSC	PAL
Camera	Image Pick-up Device	1/4" IT CCD	
	Effective Pixels	811(H) x 508(V) 410K	795(H) x 596(V) 470K
	Horizontal Resolution	768(H) x 494(V) 380K	752(H) x 582(V) 440K
	Resolution	580 TV Lines (BW 600 TV Lines), Sharpness Max.	
	S/N Ratio	50 dB (AGC Off)	
	Zoom	27x Optical Zoom, 10x Digital Zoom	
	Focal Length	f=3.6(Wide) - 97.2(Tele)mm	
	Aperture Range	F1.6(Wide)-3.7(Tele)	
	Minimum Illumination	0.5Lux (30 IRE)Color / 0.1Lux (30 IRE) B/W / DSS(128FLD) Mode : 0.0005Lux (30 IRE)	
	Day & Night	Auto / Day /Night	
	Focus	Auto / Manual / SemiAuto	
	Iris	Auto / Manual	
	Shutter Speed	Auto (x128 ~ 1/60 sec ~ 1/10,000 sec)	
	AGC	Normal / High / Off	
	White Balance	Auto / Manual(Red, Blue Gain Adjustable)	
	BLC	NORMAL,C,L,U,D,R HIGH/LOW(6 Area Selectable)	
	Flickerless	On / Off	
Brightness	Adjustable (0-96)		
Pan/Tilt	Operation Range	Pan 360 ° (Endless) / Tilt 90 °	
	Operation Speed	Preset : 360 ° / sec	
		Manual : 1 ~ 360 ° / sec (inter-locked with zoom extension)	
		Swing : 1 ~ 180 ° /sec	
	Preset Setting	127 presets (label setting, individual video setting)	
	Swing Setting	8 swings	
	Pattern Setting	4 pattern (1200 commands / pattern, 5 min)	
	Group Setting	8 groups (20 actions / group)	
Other Functions	Auto Flip, Auto Parking, Power Up Action		
General	Communication	RS-485	
	Protocol	Pelco-D, Pelco-P, Samsung and Panasonic Selectable	
	Privacy Zone(Optional)	8 Zones	
	Alarm I/O	4 inputs / 2 outputs	
	OSD Menu	On / Off	
	Input Voltage	24VAC (19VAC ~ 29VAC)	
	Input Power	48VA	
	Fuse	2A	
	Dimension	Dome Ø 149	
		Housing : Ø 209.7 x 247.2(H) mm (without Sun-Sheild)	
	Weight(Approx.)	3.8kg (without Sun-Sheild) / 4.3kg (with Sun-Sheild)	
Operational Temperature	-30 °C ~ +50 °C		

Types by installation



Pendant Mount

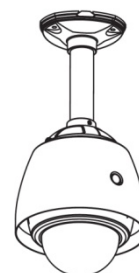

Pendant Mount (Sun-Shield)

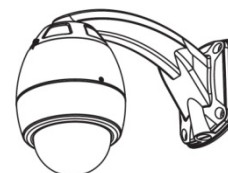

Wall Mount

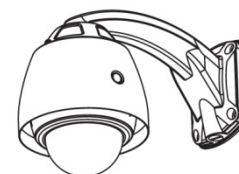

Wall Mount (Sun-Shield)

5. Specifications

36x EXview Models S2965NX /S2965PX

Video Signal		NTSC	PAL
Camera	Image Pick-up Device	1/4" EXview HAD CCD	
	Effective Pixels	768(H) x 494(V) 380K	752(H) x 582(V) 440K
	Horizontal Resolution	530 TV Lines	
	S/N Ratio	50 dB (Weight ON)	
	Zoom	36x Optical Zoom, 12x Digital Zoom	
	Focal Length	f=3.4(Wide) ~ 122.4(Tele)mm	
	Aperture Range	F1.6(Wide) ~ 4.5(Tele)	
	Minimum Illumination	1.4 Lux 1/60 sec(NT), 1/50 sec(PAL) 0.1Lux 1/4 sec(NT), 1/3 sec(PAL) 0.01Lux 1/4 sec(NT), 1/3 sec(PAL) : ICR-ON	
	Day & Night	Auto / Day / Night / WDR	
	Focus	Auto / Manual / SemiAuto	
	AE Mode	Auto / Iris / Shutter / Manual / Brightness	
	White Balance	Auto / Manual(Red, Blue Gain Adjustable)	
	BLC	On / Off / WDR	
	Flickerless	On / Off	
Pan/Tilt	Operation Range	Pan 360 ° (Endless) / Tilt 90 °	
	Operation Speed	Preset : 360 ° / sec	
		Manual : 1 ~ 360 ° / sec (inter-locked with zoom extension)	
		Swing : 1 ~ 180 ° /sec	
	Preset Setting	127 presets (label setting, individual video setting)	
	Swing Setting	8 swings	
	Pattern Setting	4 pattern (1200 commands / pattern, 5 min)	
	Group Setting	8 groups (20 actions / group)	
Other Functions	Auto Flip, Auto Parking, Power Up Action		
General	Communication	RS-485	
	Protocol	Pelco-D, Pelco-P, Samsung and Panasonic Selectable	
	Privacy Zone	8 Zones	
	Alarm I/O	4 inputs / 2 outputs	
	OSD Menu	On / Off	
	Input Voltage	24VAC (19VAC ~ 29VAC)	
	Input Power	48VA	
	Fuse	2A	
	Dimension	Dome Ø 149	
		Housing : Ø 209.7 x 247.2(H) mm (without Sun-Sheild)	
	Weight(Approx.)	3.8kg (without Sun-Sheild) / 4.3kg (with Sun-Sheild)	
Operational Temperature	-30 °C ~ +50 °C		

Types by installation



Pendant Mount

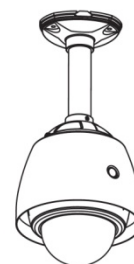

Pendant Mount (Sun-Shield)

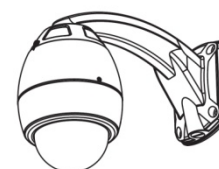

Wall Mount

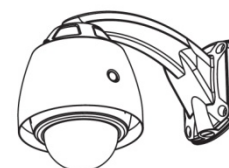

Wall Mount (Sun-Shield)

5. Specifications

⊙ Dimensional Drawings

MAIN Body (without Sun-Sheild)

Weight (Approx.) : 3.8kg

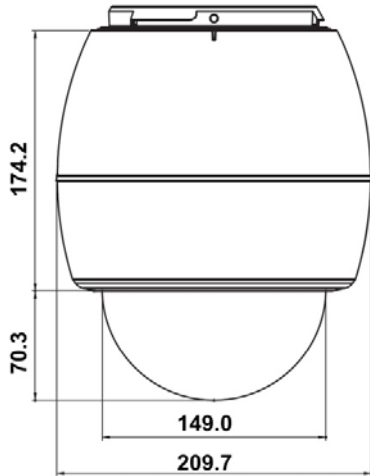

MAIN Body (without Sun-Sheild)

Weight (Approx.) : 4.3kg

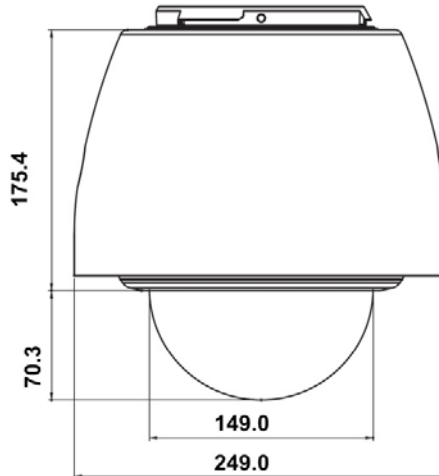

Pendant Mount Bracket

Weight (Approx.) : 1.9kg

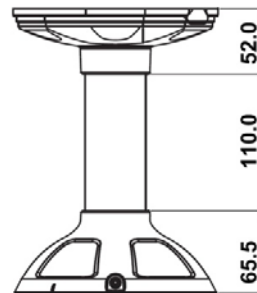
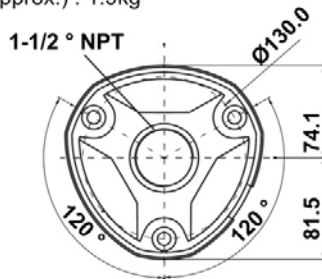

Wall Mount Bracket

Weight (Approx.) : 1.2kg

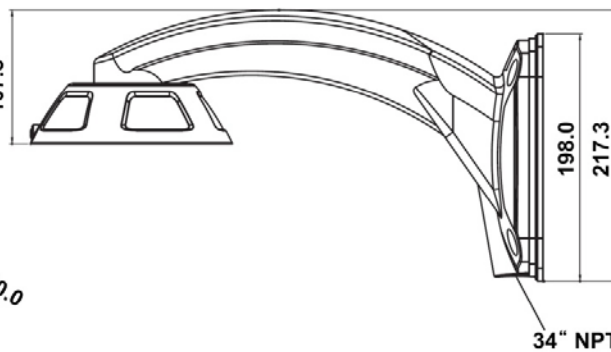
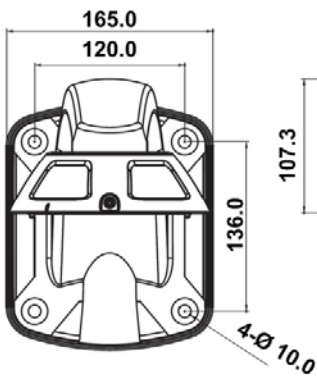

Unit (mm)

5. Specifications



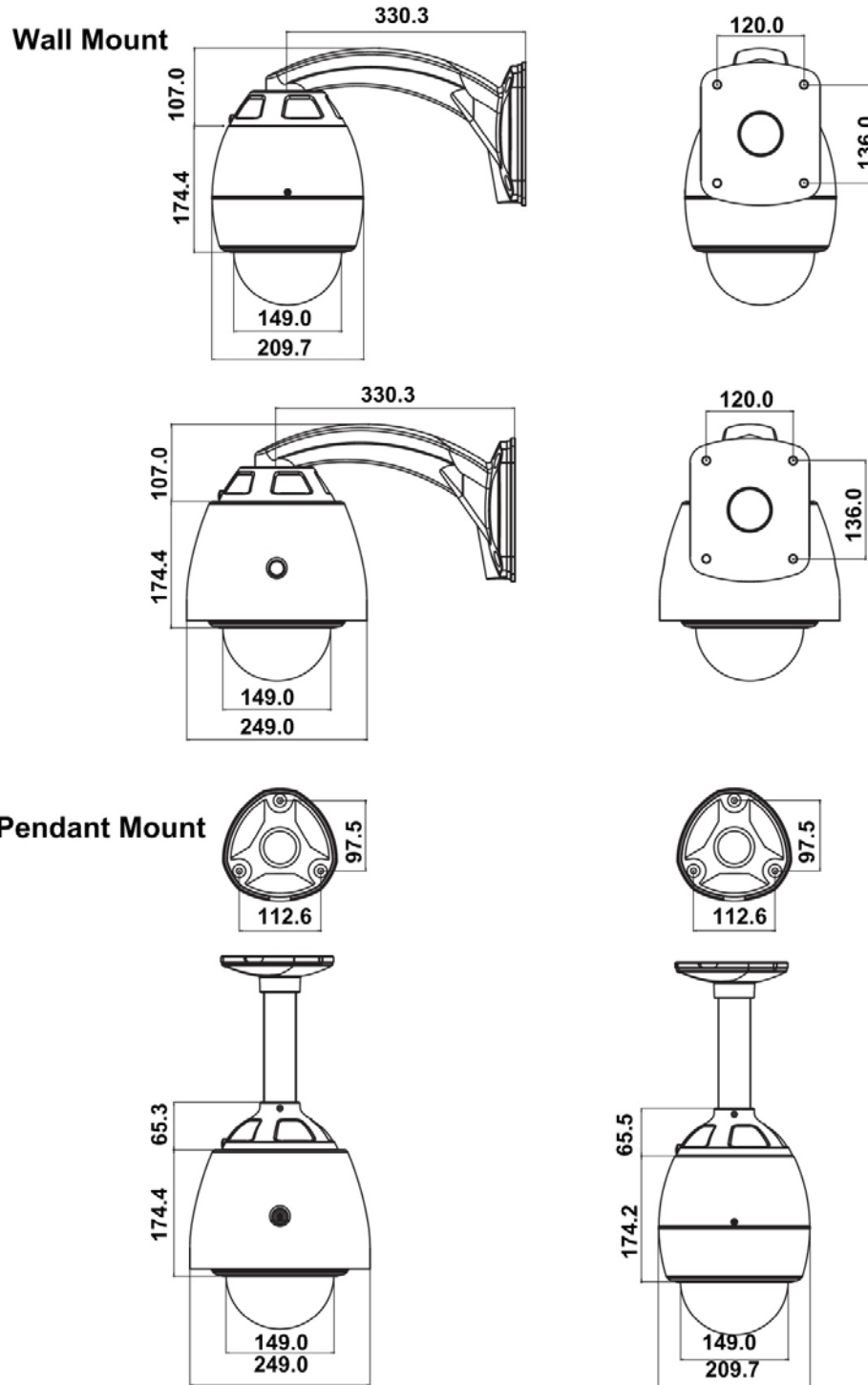



⊙ Dimensional Drawings



Unit (mm)

6. System Models & Related Accessories

⊙ System Model Numbers

타입 / 이미지	26x Day/Night(ICR) EX view HAD CCD	27x Day/Night(ICR) Super HAD CCD II	36x Day/Night(ICR) EX view HAD CCD
Wall Mount Type Without Sun Shield 	S2465NXW S2465PXW	SCN-22Z27FW SCN-23Z27FW	S2965NXW S2965PXW
Pendant Mount Type Without Sun Shield 	S2465NXP S2465PXP	SCN-22Z27FP SCN-23Z27FP	S2965NXP S2965PXP
Wall Mount Type With Sun Shield 	SS2465NXW SS2465PXW	SDN-22Z27FW SDN-23Z27FW	SS2965NXW SS2965PXW
Pendant Mount Type With Sun Shield 	SS2465NXP SS2465PXP	SDN-22Z27FP SDN-23Z27FP	SS2965NXP SS2965PXP
S.Dome Camera Without Sun Shield 	S2465NX S2465PX	SCN-22Z27F SCN-23Z27F	S2965NX S2965PX
S.Dome Camera With Sun Shield 	SS2465NX SS2465PX	SDN-22Z27F SDN-23Z27F	SS2965NX SS2965PX

⊙ Related Accessories

Wall Mount	SWB2000
Pendant Mount	SPB2000
Corner Mount	SCB2000
Pole mount	SOB2000
Sun Shield	SSS2000

MEMO